

A SERVO CIRCUIT (P.C. Board : on page 20)

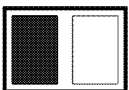

→ : Positive voltage line - - - - - : Negative voltage line ⊞ : CD signal Line

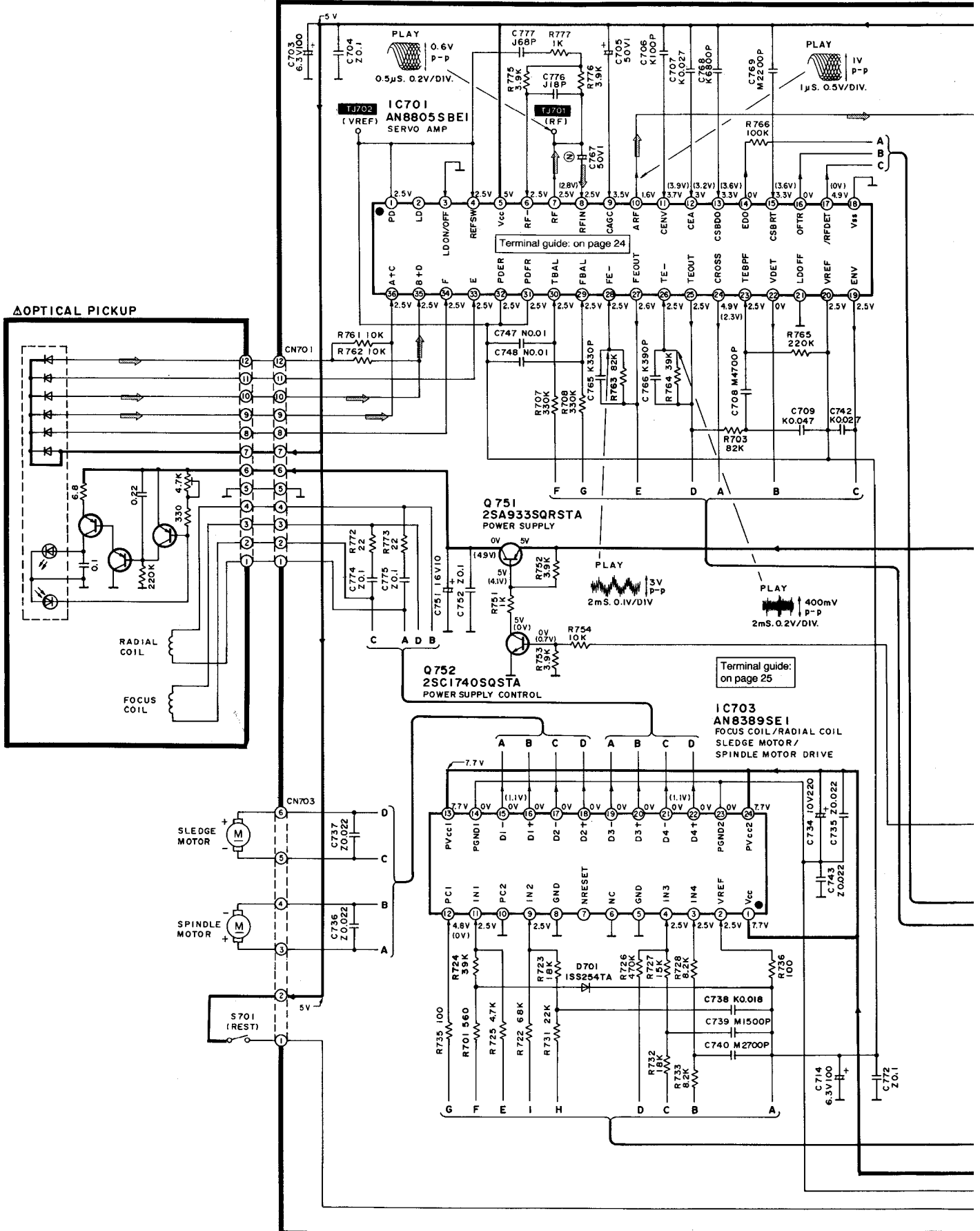
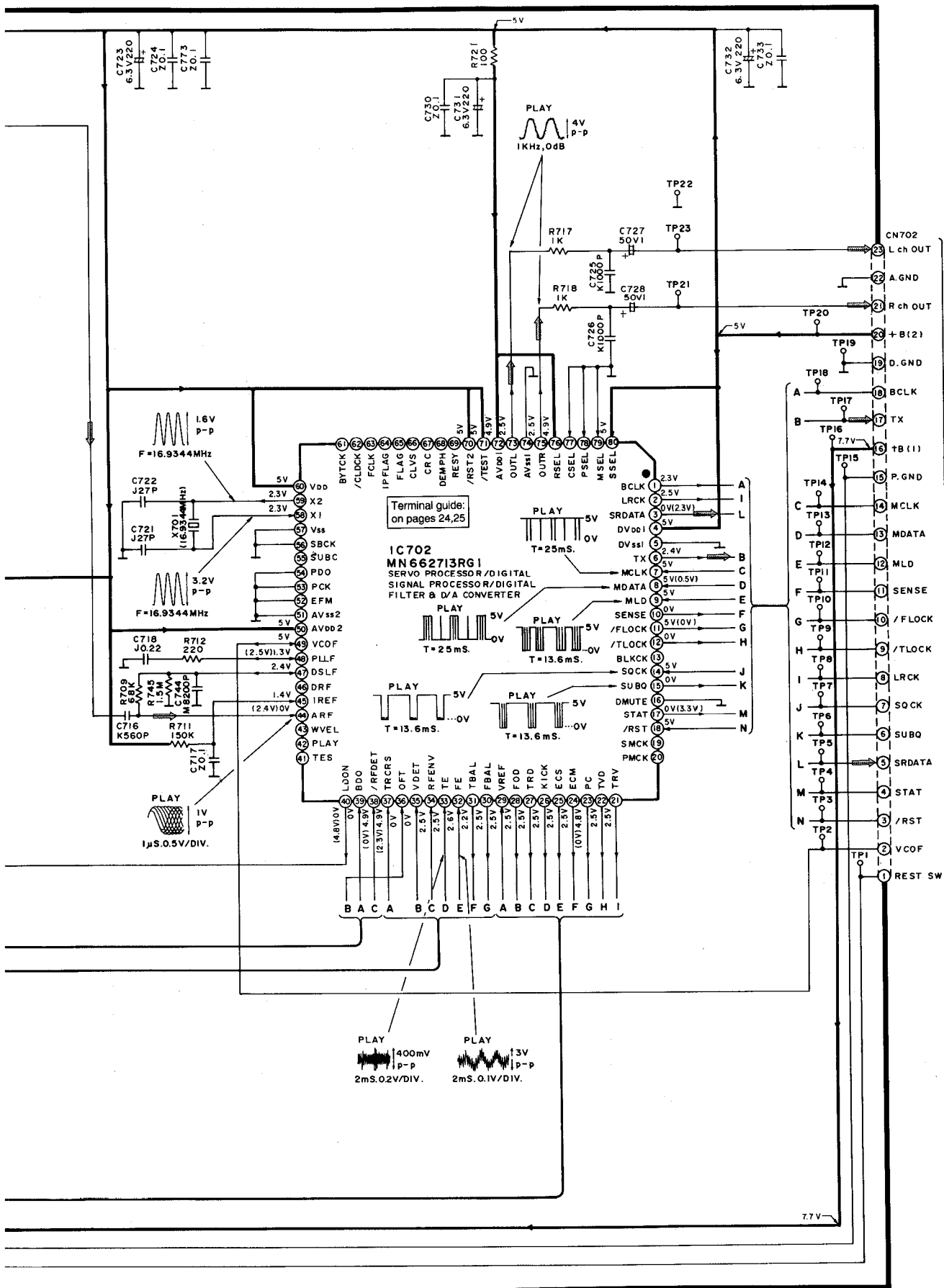

To **MAIN**
CIRCUIT
(CN401)
on page:19

7.7V

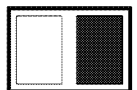

B POWER SWITCH CIRCUIT
(P.C.Board: on page 20)

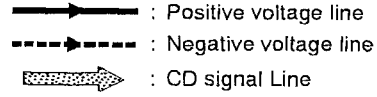
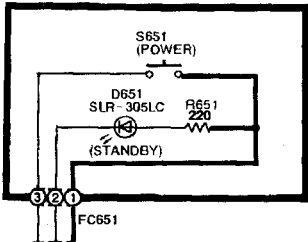

C OPERATION CIRCUIT (P.C.Board: on page 21)

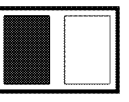
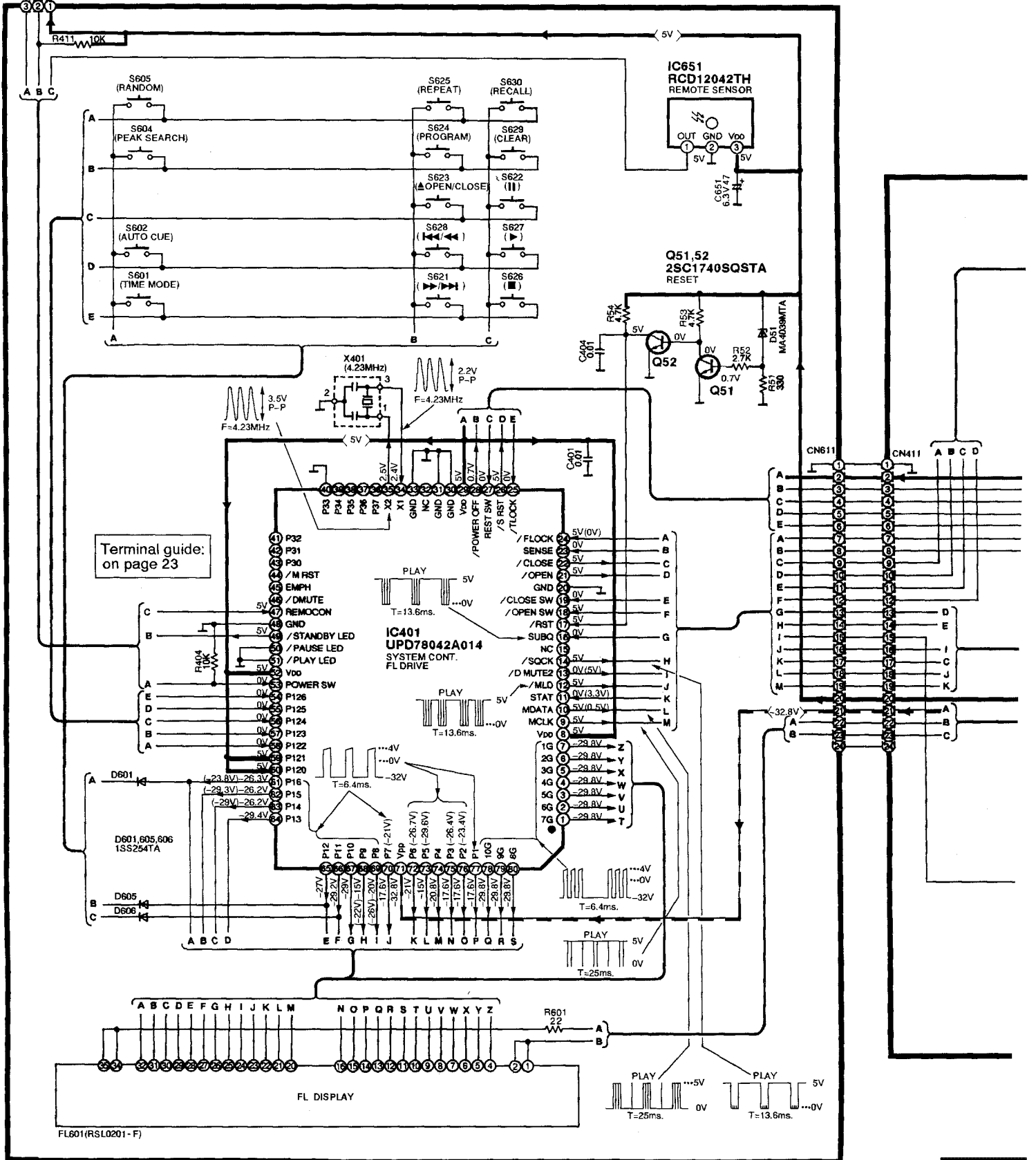

D LOADING MOTOR CIRCUIT
(P.C. Board: on page 20)

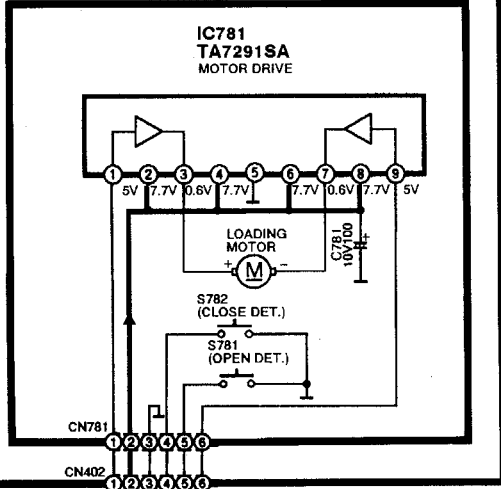

E MAIN CIRCUIT (P.C. Board: on page 21)

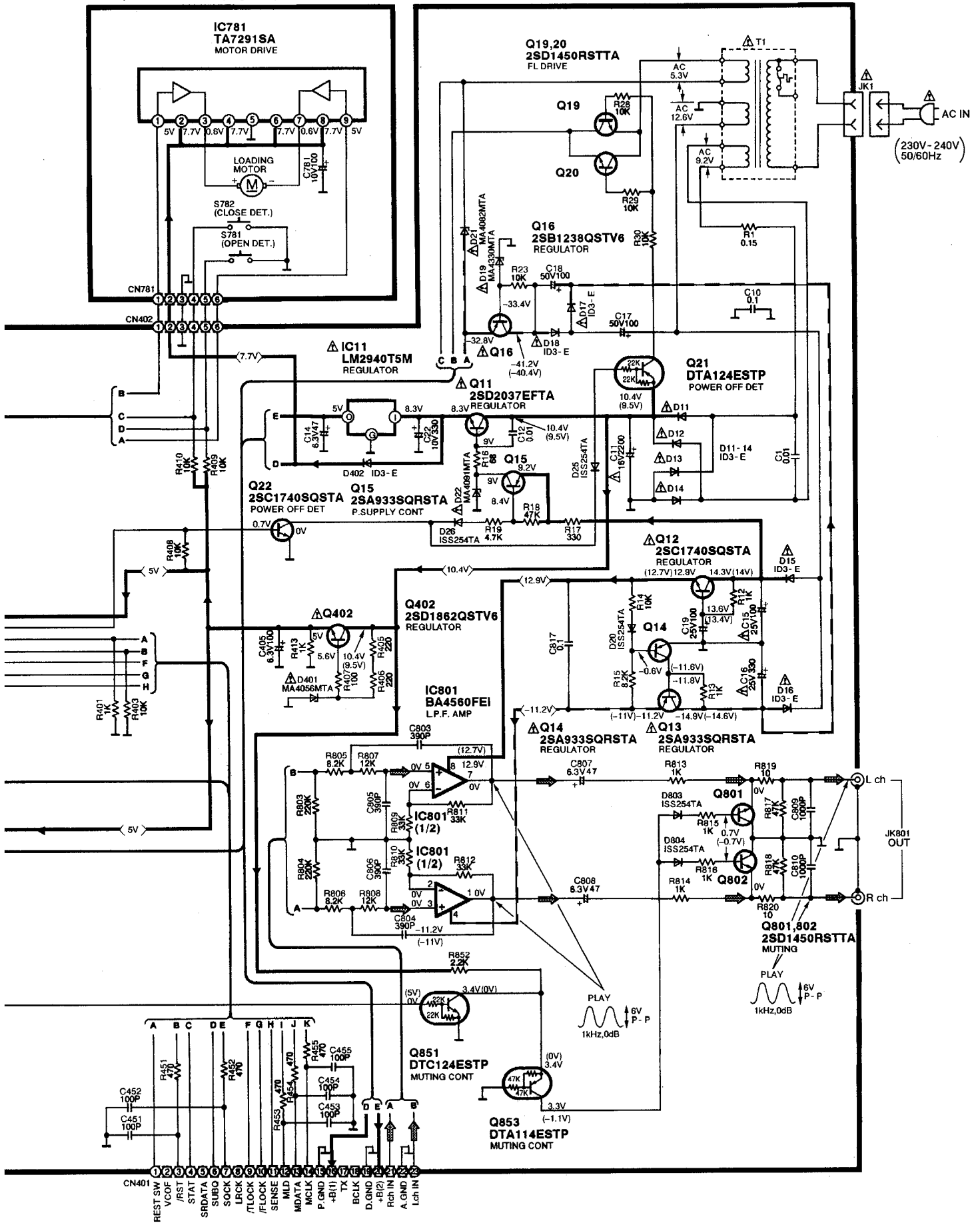

To **A** SERVO CIRCUIT (CN702) on page17

